

**Wine Cellar Cooling Units**

**Self-contained**

**User Manual**



**Thank you for purchasing this “Thenow” product;  
Please read this manual carefully before attempting to install, operate or service;  
Please retain this booklet for future reference.**

**!!! WARNING !!!**



**To avoid the risk of electrical shock, property damage, personal injury or death, please read the following instructions carefully with safety or warning labels.**

\*During transportation or moving, please follow the correct direction on the packing case.

\* After transportation or moved, it needs to be allowed to stand for more than 24 hours before it can be turned on.

\*Do not attempt to carry out any measurement, device replacement or other maintenance work not covered in this manual, otherwise it may lead to warranty failure, endanger normal operation, extend equipment downtime and increase additional maintenance costs.



**Disconnect electric power from the appliance before performing any maintenance or repairs, failure to do so could result in death or electrical shock.**

## Table of Contents

<b>1. Product Introduction.....</b>	<b>4</b>
<b>2. Dimensions &amp; Technical Data.....</b>	<b>5</b>
<b>3. Installation &amp; Debugging.....</b>	<b>7</b>
<b>4. Introduction of Controller.....</b>	<b>15</b>
<b>5. Maintenance.....</b>	<b>18</b>
<b>6. Troubleshooting.....</b>	<b>20</b>
<b>7. Warranty.....</b>	<b>21</b>

## Product Introduction

### Wine Cellar Cooling Units Through-the-Wall

Thenow through-the-wall wine cellar cooling unit is specially designed to match the demands in foreign markets. It is a ductless wine cellar cooling units with evaporator and condenser are housed together in one unit. It offers a compact design that can be applied to the unique today's do-it-yourself modern wine cellar or wine wall.

#### Features:

Compact design, flexible installation;

Quiet and efficient operation;

Build-in wet film pad and PTC heater, better control the temperature and humidity;

Intelligent control panel, famous brand sensors with stable quality, integrated ModBus connection;

Famous brand compressor, safe, stable and low energy consumption;

Traditional Chinese knot design air grille, better heat dissipation.

#### Working Principle

##### 1.Refrigeration

Using cycling vapor compression refrigeration system,when the compressor work, indraft low temperature and pressure refrigerant gas from evaporator, compressed by compressor into high temperature and pressure gas, and then into the condenser to condense into liquid, meantime release heat, after throttling under the function of the thermal expansion valve, entering into the evaporator and absorbed heat,then evaporate into gas, finally back to the compressor through the suction tube and complete a refrigeration cycle ; On the other hand,through changing of refrigerant flow direction, total or partial condensing heat generated from refrigeration can be exhausted to outside,to achieve the purpose of adjusting the indoor temperature.

##### 2. Dehumidification Principle

When the wet air flows through the evaporator surface, the air temperature will drop, when it falls below the dew point,the steam in the air will condense out, gathering and drainage of water pipes in the receiving plate, the controller automatically adjusts the compressor start-up time according to the setting humidity , so as to achieve the purpose of adjusting humidity.

##### 3. Heating

Electric heating compensation.

##### 4.Humidification

Adopt circulating water wet-film auto control humidification system, wet film is made of Swedish organic polymer material with sterilization and disinfection function

## Dimensions & Technical Data

### Dimensions HSN-JT20:

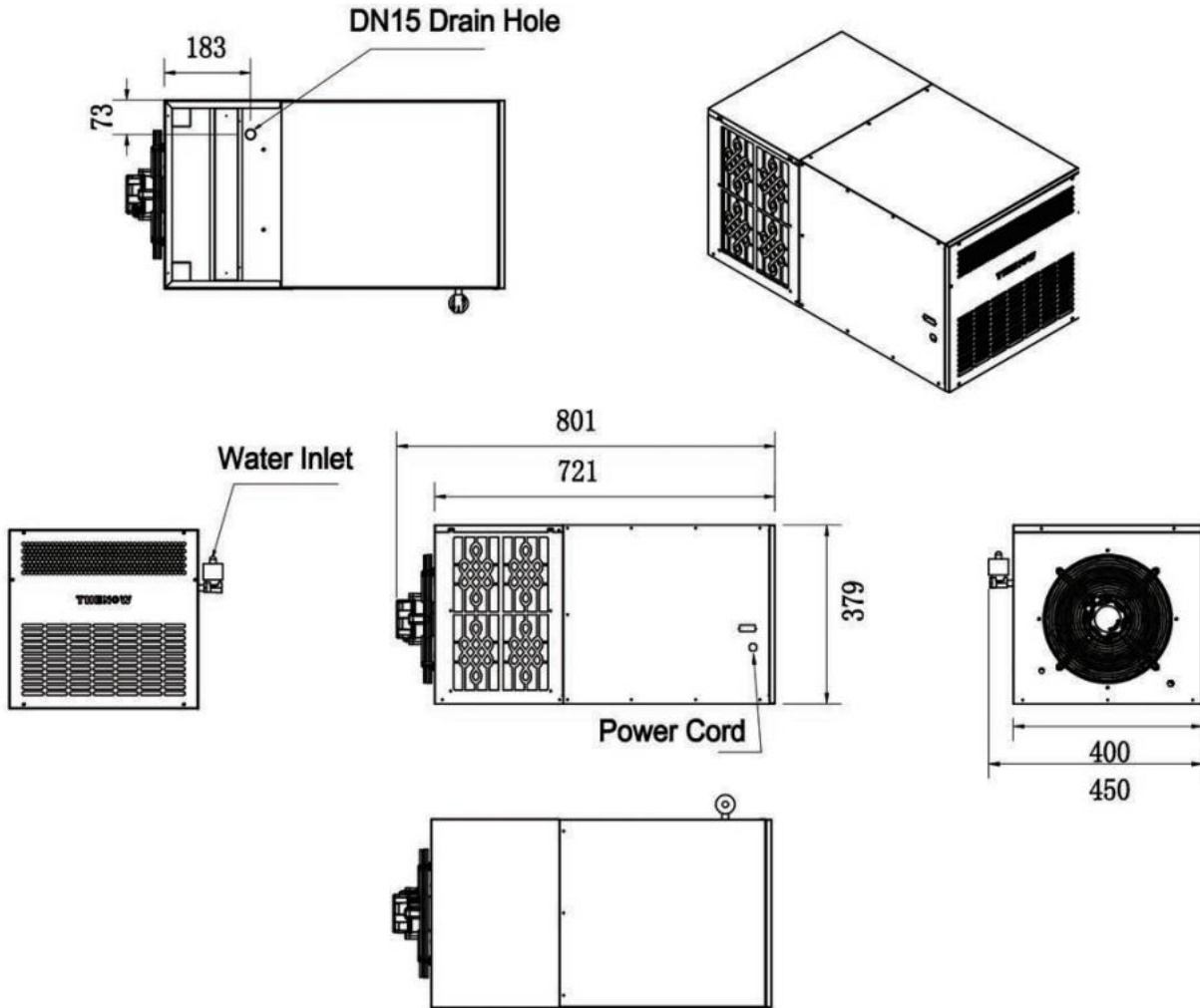

## Technical Data

Model		Unit	JT20
Cellar Size	Semi Buried	m <sup>3</sup>	4~7
	Insulated*	m <sup>3</sup>	4~12
Power		V/HZ	220V/50Hz
Cooling		KW	0.72
Heating		KW	1
Air Flow		m <sup>3</sup> /h	170
Static Pressure		Pa	30
Noise		dB(A)	42
Refrigerant		/	R290
Control		/	PC Full-touch smart control
Temperature		°C	10-18°C, ±2°C
Humidity		°C	50~70%, ±5%
Total Power		KW	1.5
Humidifier		/	Wet-film
Humidity Capacity		Kg/h	1
Dimension (L*W*H)		mm	881*450*379
Drainage		mm	φ20

**Note:** Cellar inside dry-bulb t=12°C 60% Outside dry-bulb t=35°C, wet-bulb t=28°C

Insulated\*: Cellar walls and ceiling insulation with 60mm polyurethane.

**Cellar size in above sheet is just experience value.** There are several factors such as glass, stone, concrete, insulation, ambient temperature, ventilation etc. which will change the required amount of Kw needed to properly cool your wine room or wine cabinet. We strongly recommend you contact with us or our distributors beforehand to help you to choose the model matched. We do not bear the losses caused by the selection errors caused by the above reasons.

## Installation and Debugging

### Pre Installation Inspection

- A. Check the outer packing for breakage.
- B. Machine model (nameplate), check whether it is consistent with what you ordered.
- C. The appearance of the whole machine is intact.
- D. Sit unit upright for at least 24 hours before installation.

### Check the Packing Details :

Item No.	Item	Q'ty	Dimension	
1	Cooling Unit	1 pc	801×450×379mm	
2	User Manual	1pc	A5	
3	Control Panel	1pc	90×90mm	
4	Head Outside The Wire	1pc	DN15	
5	Controller Cable	1pc	3m	
6	Flange Mounting Bracket (Through-the-wall)	1pc	446×425×100mm	
7	Supply Air Flange Cover (Optional)	1pc	399×379×41mm	
8	Return Air Flange (Optional)	1pc	φ 196	
9	Screw (Optional)	6pcs	M4	

**Note:** Item 7,8,9 are all optional accessories, if client not confirmed them before ordering, packing details will not include these items or part of them.

**Warning:** Our company is not responsible for any accident caused by opening the panel and electric control cabinet without the permission of the company.

## Installation



**Disconnect electric power from the appliance before performing any maintenance or repairs, failure to do so could result in death or electrical shock.**

Because of potential safety hazards under a certain condition, we strongly recommend against the use of an extension cord. However, if you still elect to use an extension cord, it is absolutely necessary that it will be a related national standard LISTED 3-wire grounding type appliance extension cord having a 3- blade grounding plug and a 3-slot receptacle that will plug into the appliance. The marked rating of the extension cord shall be 220V 15A.

### Installation Conditions

1. After the unit is installed, the inclination angle of the installation plane cannot exceed 1 degree, and the installation bracket or platform should be able to bear the weight of the unit.
2. In order to ensure good ventilation performance of the unit and daily maintenance and repair, it is required to leave enough space for machine disassembly and maintenance work.
3. There should be no strong magnetism, steam, or dust around the unit, meantime, ensure that there are no heat sources, corrosion, and combustible gases in the installation area.
4. After the unit is installed, there should be enough heat dissipation space on the condensing side to ensure ventilation.

\* The ventilation and heat dissipation of the unit play a vital role in the normal operation and performance guarantee of the unit. When the unit is running in 'constant temperature' and 'automatic' mode, a large amount of heat will be generated on the condensing side of the unit. In order to dissipate the heat smoothly, the condensing side of the unit needs to be ventilated well, otherwise it will affect the unit's overall performance and lifespan. If there is no ventilation on the condensing side of the unit, it is necessary to install an exhaust fan for forced ventilation.

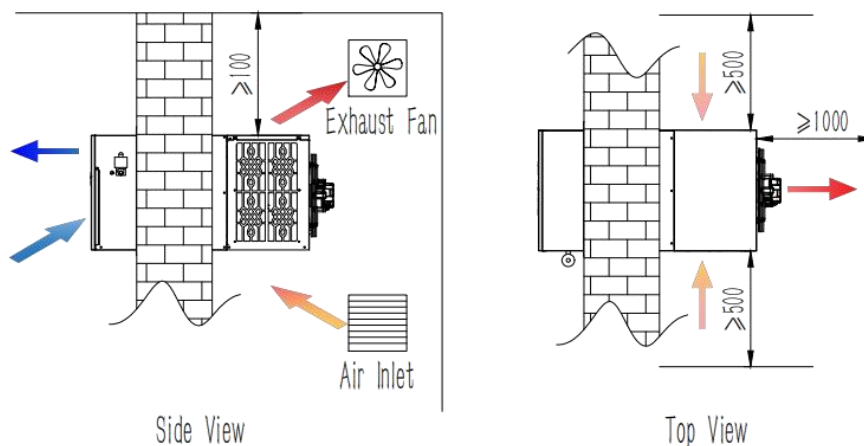



5. To avoid any air leakage, before install the unit, foam tape needs to be placed in the bottom and side of the unit.

6. Working environment: Temperature 5°C-35°C , Humidity RH<80%

7. Recommend air duct: A- Heat-insulating phenolic board, thickness 15~20mm

B- Stainless steel duct, 20mm insulation

8. When connecting the air duct, supply air flange cover and return air flange are recommended to choose. The connection between the air duct and the unit should be sealed without air leakage.

9. If the unit is installed in a high-temperature and high-humidity environment, it is recommended to paste rubber and plastic insulation cotton with a thickness of more than 10mm on the surface of the unit to avoid condensation on the surface of the unit.





10. If the unit is connected to the air duct to supply air, it must be ensured that the pressure loss of the air duct does not exceed the static pressure outside the unit. (It is recommended that the total length of the air duct should not exceed 6 meters, and the air flow in the air duct should not exceed 3m/s.) If the condensing side of the unit is installed outdoors, an air conditioner rain cover should be installed.



**In order to avoid fire or electric shock hazard, please do not expose the equipment to damp environment.**

## Installation Steps

### 1. Mounting Tools

Item No.	Item	Photo	Item No.	Item	Photo
1	Level		3	Screwdriver	
2	Hammer		4	Saw	

### 2. Make sure installation location

Choosing the wall surface where the unit will be installed, and find out the position of the wall studs. The unit installation should avoid the wall studs;

Make sure the installation position of the unit on the wall, and the distance from the top of the unit to the ceiling shall not be less than 100mm.

Mark hole location for the unit, outline a rectangle 412mm(width) by 391mm(height) where the unit will be placed into the wall.

Next, using a saw cut the hole in the drywall, Be careful not to cut into any electrical lines or plumbing.

### 3. Insert the mounting flange bracket

Slide the flange mounting bracket into the hole so that the flange is flush with the wall, and fixed it firmly to the wall with screws.

Make sure the mounting bracket flat without tilted, using airtight sealant or caulking seal the flange sides and bottom to the wall as needed.

### 4. Fixed the mounting flange bracket

Through the 8 fixing holes on the front of the flange bracket, use screws to fix the flange on the wall, make sure that the screws are flush with the flange surface of the bracket, and must not be over-tightened or over-loose.

### 5. Mounting the unit

Slide the unit in along the mounting flange bracket. Slide the condensing fan side of the device into the bracket until the desired depth is reached, making sure that the humidification solenoid valve and power cord of the device do not touch the flange of the bracket.

### 6. Seal all cracks and gaps

Seal all cracks and gaps around the unit with an airtight sealant or caulking to prevent air leakage and movement of the unit

### 7. Attach the condensate drain line

Note: The drain line must be connected well before starting the unit.

There is a condensate drain hole at the bottom of the unit on the condensation side, and the diameter of the condensate drain is DN15

- a. It is recommended to connect the water seal at the bottom of the condensate drain pipe, and the other end of the drain pipe should be placed in a bucket or directly connected to the drain pipe;
- b. If the other end of the drain pipe is placed in a bucket, the bucket must be emptied in time to avoid water

overflowing the bucket or prevent mold from water growing. If the machine runs for a long time, it is recommended to connect the drain pipe to the open floor drain or sink.

c. The drain at the bottom of the unit needs to be connected to a water seal. The size of the water seal is shown in the attached picture (users prepare the water seal by themselves).

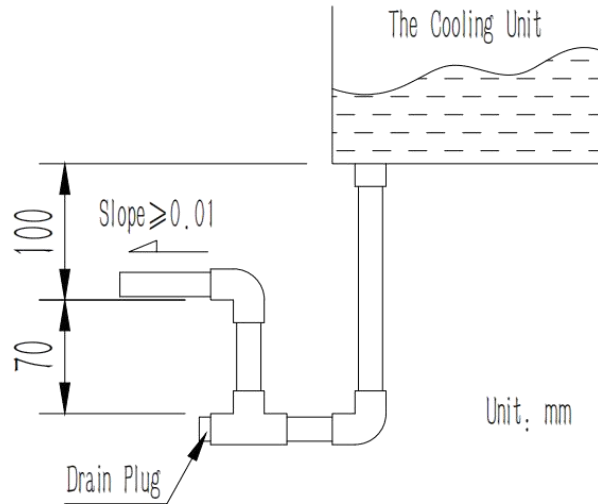

#### 8. Connect the water inlet pipe

Note: The water inlet pipe for humidity must be connected well before starting the unit.

There is a humidification water inlet interface on the right side facing the air outlet of the unit, and the diameter of the humidification water supply pipe is DN08

- a. Connect the manual water flow regulating valve to the humidification water inlet pipeline.
- b. Purified water is preferred for humidification. If there is no pure water, tap water can also be used. Avoid limescale as much as possible, or it will affect the humidification effect.
- c. To better control the wet-film water inlet flow rate, electromagnetic water valve and water flow gauge are suggested to be installed. Otherwise, the water will always be supplied to the machine in a normally open state, which will cause the equipment to leak and fail to operate.

Below suggested water flow rate of Thenow self-contained cooling units for your checking: ( Unit: L/M)

Model	HSN-J15-Z	HSN-JC8	HSN-JT20
Inlet Water Rate	0.5	1	1.8

Note: Make sure the smooth drainage too.

**Common Mounting Methods:**

**HSN-JT20 I: Through-the-wall**

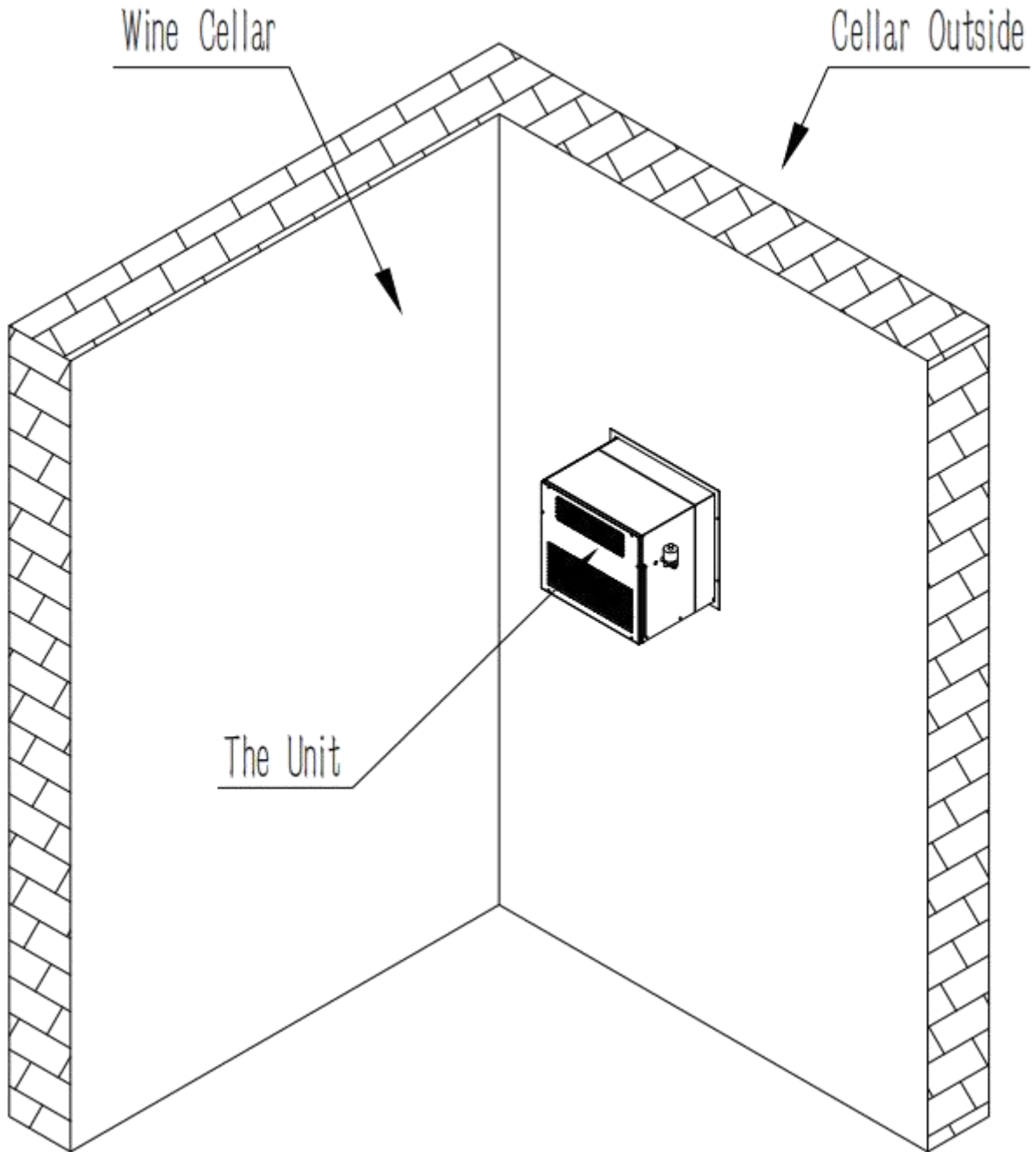

**HSN-JT20 II : Duct Work**

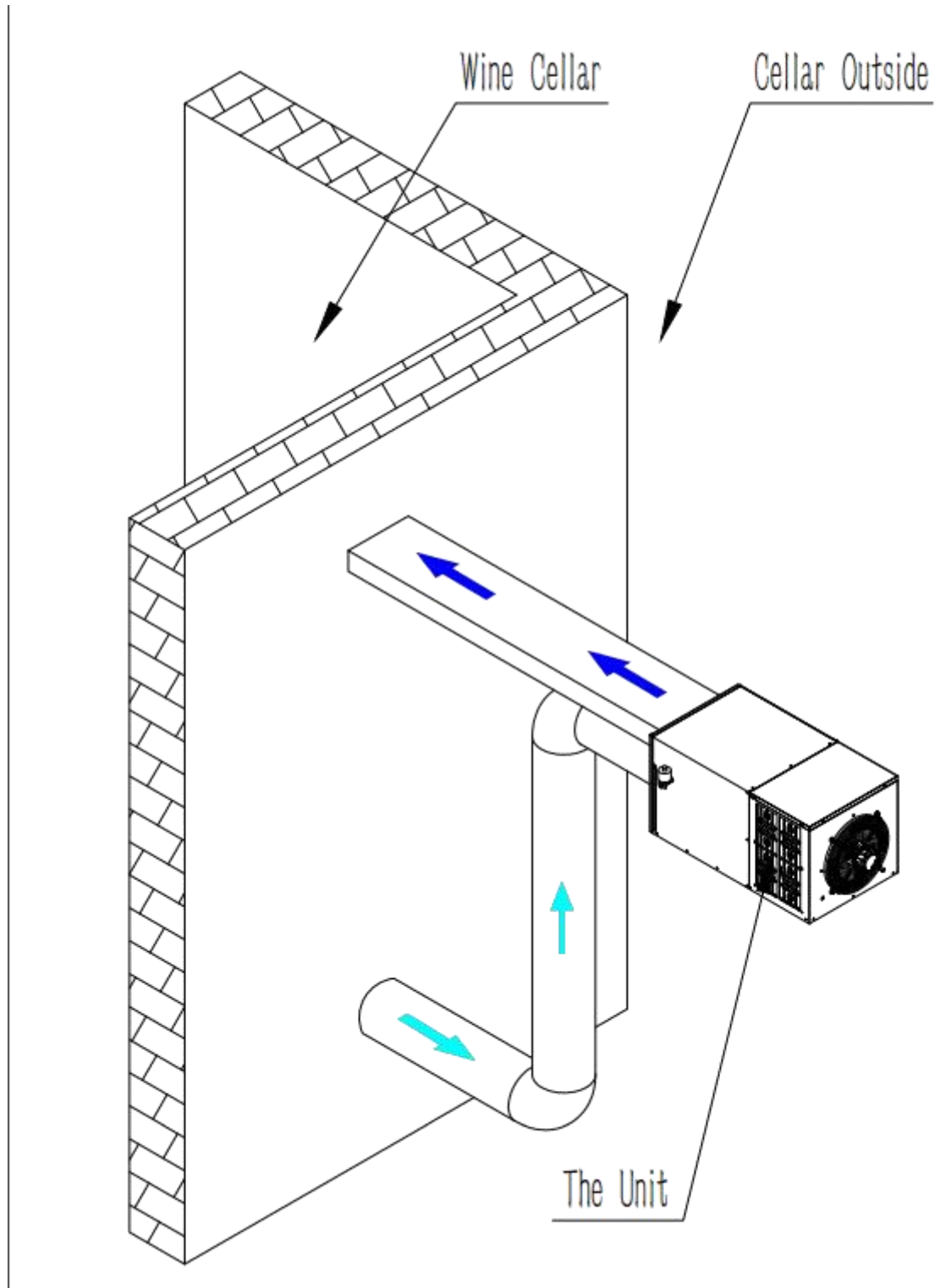

## Online Debugging

### 1. Preparation work before starting the unit

- a. Confirm that the power supply of the user distribution box is single-phase 220V, the fluctuation range does not exceed 10%, and the capacity of the distribution box meets the unit use requirements;
- b. Refer to the internal electrical schematic diagram of the unit to complete the wiring, and at the same time ensure that the unit is effectively grounded;
- c. Before starting up and running, make sure that the unit has been installed correctly, the air supply outlet and the return air inlet have been sealed to ensure no air leakage, no obstruction of condensation air intake, sufficient heat dissipation space, and the controller panel has been installed correctly;

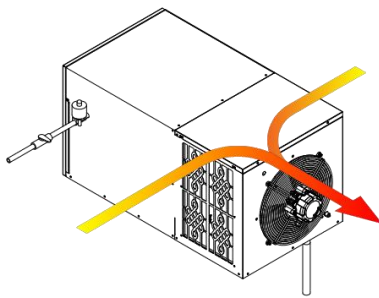

Condenser Airflow Pathways

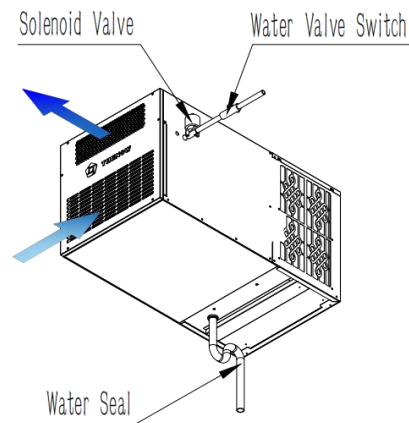

Supply and Return Airflow Pathways

- d. Connect well the humidification water pipe, the humidification water supply is smooth, and adjust the manual water valve switch to make the water flow appropriate (customer-provided manual water valve switch);
- e. The drain at the bottom of the condensing side is connected to the water seal, and the water seal drain is led to an empty bucket or an open floor drain or sink.

After everything is in good condition, perform the following operations:

- 1.) Power the machine.
- 2.) Turn on the unit. Set the unit running mode at 'Auto' , input the setting temperature and humidity, refer to controller functions in this manual.
- 3.) Testing the fan. Factory default is 'AUTO' fan operation, under this the fans runs continuously between the two speed when the unit is calling for cooling. Users can also change the fan operation from 'AUTO' to 'Manual'

operation, choosing it running at high speed or low speed freely.

4.) Running the unit. Check unit to confirm the compressor is running, such as the hum of the compressor or cool air leaving the unit. Check for any unusual noise or vibration, such as clanking or rubbing.

**After the machine runs for 30 minutes or several hours, up to a day or more:**

1. Check the alarm record. If all functions work well, no alarm record will be generated.
2. Check the machine for leaks.
3. Check whether the temperature is lower than that when the machine is started. Generally, the coil temperature is reduced by 5-14°C as the normal range.
4. If the cooling of the unit can operate normally and there is no water leakage, the debugging work is completed.

**Note:** After transportation or moved, it needs to be allowed to stand for more than 24 hours before it can be turned on.

## Introduction of Controller

**Controller Introduction:**

CK-4C-86 series controller is a new type of controller to realize intelligent control of constant temperature and humidity for a wine cellar and wine cabinet cooling units, which is widely used in precise temperature control places with small volume.

The controller adopts 4-inch large -screen colorful display technology, timing control, automatic/manual control of air flow speed , automatic operation of the appropriate air flow speed , comfortable energy saving , accurate and reliable.

**Functional features:**

1. With 4-inch capacitive full-touch display, clear picture and easy to operate.
2. Real-time display of temperature, humidity and clock.
3. Timing control.
4. Fan speed manual/automatic control selection.
5. Multiple operating mode options.
6. Built-in advanced parameter settings, manufacturers can freely set according to different customer needs.
7. Standard 86 mounting bottom case for quick and easy installation.
8. Power off and restart function.
9. Alarm can be remembered.

### Technical Specifications

Power Supply	PCB: AC220V±10% 50/60HZ
	Display: DC12V
Shell Material	Flame retardant ABS+PC
Power	<12W
Pich of Installation	60mm
Size	PCB: 123mm×85mm
	Display: 91mm×90mm
Storage Environment	-10~~70℃ 5%~~95%RH
Working Condition	-10~~70℃ 5%~~95%RH

### Product installation:

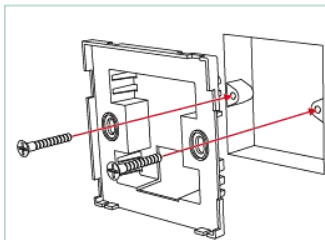

1. Remove the plastic frame and screw from the packaging box, and then install and fix the plastic frame to the 86 mounting box inside the wall after the wire is threaded out of the plastic frame.

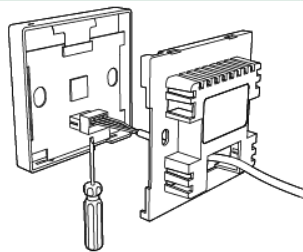

2. Correct Wiring according to electrical connection diagram and wiring marking.

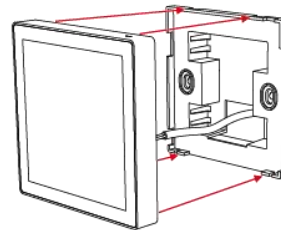

3. Snap the product lower point to the plastic frame, then press and hold the upper part of the product into the plastic frame.

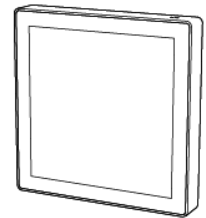

4. Confirm whether the shell is fastened and the installation is completed.

1. Remove the plastic frame and screw from the packaging box, and then install and fix the plastic frame to the 86 mounting box inside the wall after the wire is threaded out of the plastic frame.
2. Correct wiring according to electrical connection diagram and wiring marking.
3. Snap the product lower point to the plastic frame, then press and hold the upper part of the product into the plastic frame.
4. Confirm whether the shell is fastened and the installation is completed.





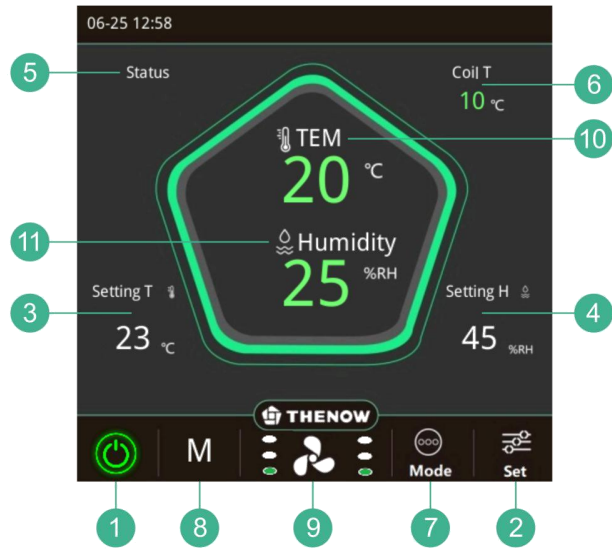

**Functions:**

1. Turn ON/OFF the unit
2. Setting
3. Setting temperature
4. Setting humidity
5. Running mode display
6. Coil temperature
7. Running Mode Setting
8. Fan running mode(Manual/Auto)
9. Fan speed
10. Cellar temperature
11. Cellar humidity

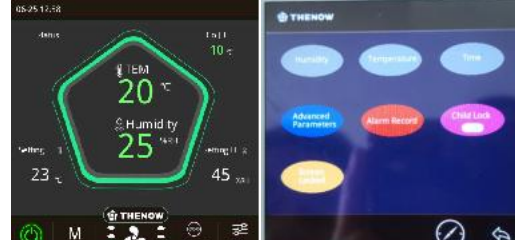

**Note:** Because all Thenow Cooling Units are using same displayer now, for the single cooling unit like JC8, some functions indicating above are not available. Very regretful for the troubles may bringing to you.

<p>Turn system ON/OFF</p>		<p>Touch the switch icon in the lower left corner to turn on or off the unit Color red is on and green is off</p>
<p>Set temperature</p>		<ol style="list-style-type: none"> <li>1. Touch icon 'Set'</li> <li>2. Find 'Temperature', click to enter and set temperature</li> </ol>
<p>Set humidity</p>		<ol style="list-style-type: none"> <li>1. Touch icon 'Set'</li> <li>2. Find 'Humidity', click to enter and set humidity</li> </ol>
<p>Set time</p>		<ol style="list-style-type: none"> <li>1. Touch icon 'Set'</li> <li>2. Find 'Time', click to enter and set time</li> </ol>

<p>Mode</p>		<p>Touch icon 'Mode' to choose the running mode, default value is 'Auto'</p>
<p>Fan Running Mode</p>		<p>Touch icon next to the switch, choosing the running mode of the fan at 'A' or 'M' (A-Auto running speed, M-Selecting running speed manually)</p>
<p>Set the fan speed (Only available at the fan work under "Manual" running mode)</p>		<p>Touch the fan icon to change the fan speed</p>

## Maintenance

### 1、 Using Requirements

- (1) Working conditions: Surrounding temperature at 5°C-35°C, relative humidity lower than 90% ;
- (2) Please make certain power supply is specified voltage, it's strictly prohibited to operate equipment with phase missing or under voltage;
- (3) If the equipment has not been used for a long time ,please make sure to turn off the power.

### 2、 Cleaning and Replacing



**Disconnect electric power from the appliance before any operation, otherwise there will be the risk of electric shock.**

1. Because the temperature probe is a sensitive element,in dusty place,please use low pressure water to clean regularly (for example,with the dust ball blowing wash),when the accuracy become poor, please correct or replace;
2. The return air outlet of this product is equipped with a filter to filter the dust in the wine cellar. The air filter

should be cleaned at least once every six months under the running environment of the wine cellar.

The cleaning steps are as follows:

- a. Please unplug the power supply without taking out the unit, as shown in the figure below, first remove the air filter cover shown in number 4 in the figure.
- b. As shown in No. 3 in the figure below, take out the air filter to be cleaned, clean it and dry it. After cleaning, put back the filter according to the original method;
- c. Install the filter cover (number 4) and fix it firmly.

3. This product uses a wet film for humidification, and the wet film pad need to be replaced every 3 years.

The replacement steps are as follows:

- a. Please unplug the power supply without taking out the unit, as shown in the figure below, first remove the front cover shown in number 1 in the below figure.
- b. As shown in No. 2 in the figure below, take out the humidifying wet film pad to be replaced and put in a new one. Note that the direction and placement of the wet film pad must be the same as the original one without bending and deformation, otherwise it will directly affect the humidification effect..
- c. After the replacement work is completed, install and restore the unit front cover (number 1) and fix it firmly.

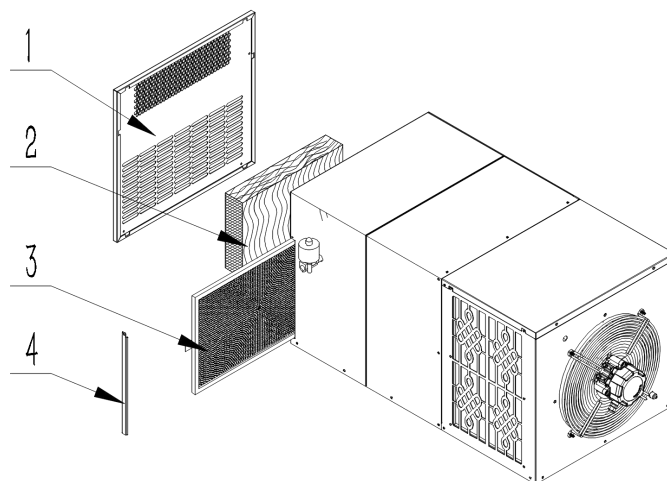

## Troubleshooting



**WARNING**



**Disconnect electric power from the appliance before performing any maintenance or repairs, failure to do so could result in death or electrical shock.**

- If maintenance is needed, wait for 3 minutes after power failure (let capacitor discharge on PCB), and then open the maintenance door.
- The surface temperature of the condenser may be very high. Do not touch it to prevent burns.
- Even if the fan and compressor have stopped, there is still a dangerous voltage at the terminals of the starting capacitor.

### Troubleshooting

Status	Reason	Suggestion
Cooling unit not running	<ol style="list-style-type: none"> <li>1. No power.</li> <li>2. Power cord unplugged.</li> <li>3. Low voltage.</li> <li>4. Incorrect or loose wirings.</li> <li>5. Ambient temperature above 35°C or lower 5°C.</li> <li>6. Setting higher than ambient temperature.</li> <li>7. Defrosting mode on.</li> </ol>	<ol style="list-style-type: none"> <li>1. Check power at receptacle &amp; fuses.</li> <li>2. Plug-in power cord plug.</li> <li>3. Contact an authorized electrician.</li> <li>4. Check all wirings and connections.</li> <li>5. Ambient temperature not meet unit working conditions.</li> <li>6. Lower temperature setting .</li> <li>7. Wait 5-30minutes.</li> </ol>
Cannot dehumidification	<ol style="list-style-type: none"> <li>1. Inlet or outlet air grille is stuck.</li> <li>2. Air filter is stuck.</li> <li>3. Refrigerant leakage.</li> <li>4. Compressor not working.</li> <li>5. Fan is not working</li> </ol>	<ol style="list-style-type: none"> <li>1. Please check the air grille and clean it.</li> <li>2. Check air filter.</li> <li>3. Add refrigerant.</li> <li>4. Check whether the compressor is normal.</li> <li>5. Check the fan.</li> </ol>
No air exhaust	<ol style="list-style-type: none"> <li>1. The air supply is blocked.</li> <li>2. Fan is not working.</li> </ol>	<ol style="list-style-type: none"> <li>1. Check and clean air outlet.</li> <li>2. Check the fan.</li> </ol>
Louder noise	<ol style="list-style-type: none"> <li>1. Loose parts.</li> <li>2. Air filter is stuck.</li> <li>3. The unit is not installed smoothly.</li> </ol>	<ol style="list-style-type: none"> <li>1. Check parts.</li> <li>2. Clean filter.</li> <li>3. Install the machine smoothly.</li> </ol>
Temperature too high	<ol style="list-style-type: none"> <li>1. Setting too high.</li> <li>2. Improper cabinet seals.</li> <li>3. Ambient temperature too high.</li> <li>4. Cabinet/room too large.</li> <li>5. Fan fault.</li> <li>6. Refrigerant leakage.</li> </ol>	<ol style="list-style-type: none"> <li>1. Lower setting.</li> <li>2. Check gasket and door opening.</li> <li>3. Check installation location.</li> <li>4. Check for excessive size or the machine model choice is improper.</li> <li>5. Check both evaporator and condenser fans.</li> <li>6. Add refrigerant.</li> </ol>

Unit running too long or continually	<ol style="list-style-type: none"> <li>1. The machine model choice is improper or improper room sealing.</li> <li>2. Ambient temperature too high.</li> </ol>	<ol style="list-style-type: none"> <li>1. Check machine mode or check room tightness.</li> <li>2. Check installation location or increase setting.</li> </ol>
Evaporator icing	<ol style="list-style-type: none"> <li>1. Evaporator airflow restricted.</li> <li>2. Unit not stopping due to air leak, high ambient temperature or low setting.</li> <li>3. Low ambient temperature.</li> <li>4. Bad thermostat or sensor.</li> <li>5. Refrigerant leaking.</li> <li>6. Expansion valve blockage.</li> </ol>	<ol style="list-style-type: none"> <li>1. Check the fan.</li> <li>2. Check the sealing of the unit, ambient temperature and setting temperature.</li> <li>3. Defrost the unit</li> <li>4. Check for thermostat and sensor.</li> <li>5. Check for sealed system leakage.</li> <li>6. Check for low side pressure.</li> </ol>
The fan keeps running	<ol style="list-style-type: none"> <li>1. Fan protection procedure.</li> <li>2. Wrong wiring harness connection.</li> </ol>	<ol style="list-style-type: none"> <li>1. Wait 3 minutes.</li> <li>2. Check harness links.</li> </ol>
No cooling but compressor running	<ol style="list-style-type: none"> <li>1. Refrigerant leakage.</li> <li>2. Evaporator airflow restricted.</li> </ol>	<ol style="list-style-type: none"> <li>1. Check of refrigerant.</li> <li>2. Check for airflow through evaporator.</li> </ol>



The above information is for reference only. If the machine fails to work properly, please contact your local dealer or your local authorized repair station.

All electrical installation and maintenance work in this manual must be performed by a professional electrical engineer.,our company is not responsible for opening the panel and electric control cabinet without the permission of the company.

## Warranty

### Limited Warranty

The machine provided by our company is guaranteed for one year and the fan is guaranteed for two years and the compressor for three years from the date of arrival. During the warranty period, any defects due to workmanship or materials, we guarantee to repair or replace the machine free of charge. (warning: the machine due to the use of dust ,corrosive liquid and other non-machine quality reasons for damage is not covered by the warranty.

### Commitment in after-sales service

During the warranty period, our company is responsible for the maintenance of the equipment, if the equipment exceeds the warranty period, our company will charge for reasonable maintenance cost.

### Other preferential terms

Our company provides free technical advisory services to users.

## Shanghai Thenow Purification Technology Co.,Ltd

Factory Add: No. 59 Linsheng Road, Tinglin Town, Jinshan District, Shanghai, China

[www.thenowair.com](http://www.thenowair.com)

Email: [sales@thenowair.com](mailto:sales@thenowair.com)

Service Line: 400-187-8599